



## HYDRAULIC EXCAVATOR | JS240/260 LC/SC/NLC

Engine power: 140kW (188hp) Bucket capacity: 0.65 – 1.65m<sup>3</sup> Operating weight: 25920 – 28500kg





# STRENGTH, INSIDE AND OUT.

BEFORE YOU BUY AN EXCAVATOR, YOU NEED TO KNOW IT'S GOING TO BE TOUGH ENOUGH TO PERFORM ANY JOB YOU ASK OF IT. FORTUNATELY, WITH A JCB JS240/260, STRENGTH AND DURABILITY COME AS STANDARD.



1

## Boom and dipper

1 A JCB JS240/260's reinforced boom and dipper is made of high tensile strength steel, with single piece wrapper plates and internal baffle plates for long life durability.

2 Our advanced manufacturing and assembly processes produce high precision and quality assembled components.



2

## Componentry

3 JCB JS240/260's boast the best components in the industry, including Berco running gear, Kawasaki pumps and Kayaba main control valves.

4 The ISUZU Tier 4i compliant engine uses a multi-stage fuel filtration system. This consists of water separation and first stage 10 micron filtration followed by 2 micron fine filtration and finally an ultra-fine 2 micron filter.



3



4



We use Finite Element Analysis with extensive rig and endurance testing to make key components last longer.





### Structural strength

- 5 The high-strength undercarriage of a JCB JS240/260 uses a fully-welded X frame construction for long-term durability even in the most demanding applications.
- 6 A closed box section revolving frame increases strength and reduces stress. It is also highly resistant to impact damage.
- 7 The JS240/260's high-strength rigid upper frame provides maximum durability and support.
- 8 Our stiff, durable door design gives great strength and rigidity.

**UNEARTHED: KEY FACT**  
 The JCB JS240/260 turret is welded to both the upper and lower undercarriage frame.

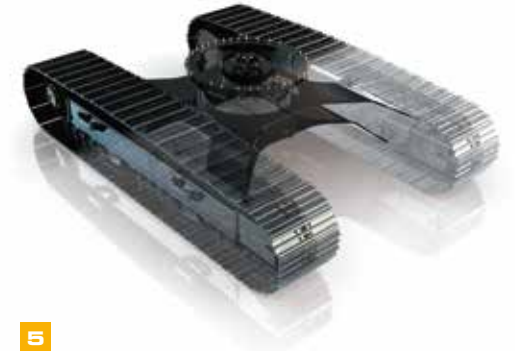

5



6



8



7



# MAXIMUM PRODUCTIVITY, MINIMUM SPEND.

IT'S MORE IMPORTANT THAN EVER TO SAVE MONEY AND TIME; THE JCB JS240/260 RANGE IS DESIGNED TO MAKE THE MOST OF BOTH.



## Upping output.

**1** With up to a massive 272kN of bucket tearout and fast cycle times, the JS240/260 is extremely productive in all applications

**2** Simultaneous tracking and excavating is smooth and fast with an intuitive multifunction operation.

## Efficiency.

Advanced hydraulic technology ensures that the machines always starts in idle for maximum fuel efficiency, contributing to fuel savings.

Optimised hydraulic pump settings and a revised spool configuration within the main valve block, only delivers the required oil flow, preventing wasted energy.



**3** This intelligent but easy-to-use AMS system controls all the machine's major functions for maximum productivity and fuel efficiency, and minimum operating costs. A compact design with an anti-glare screen and clear and easy to use interface.

The AMS also alerts you the instant there's a problem and records all the machine's key operating data: the time it has spent in each mode, attachment hours used, tracking time, and much more.



1



**UNEARTHED: KEY FACT**

To save fuel, JCB Auto-Idle technology automatically reduces engine speed when hydraulics aren't in use.



**Stability, hydraulics and attachments.**

4 JCB's innovative hydraulic regeneration system means oil is recycled across the cylinders for faster cycle times and reduced fuel consumption.

5 A JCB JS240/260 has cushioned boom and dipper ends to prevent shock loadings, protect your machine and increase operator comfort.

6 A JCB JS240/260 has a solid, stable work platform for fast cycle times.

For ultra versatility, JCB offers a full list of auxiliary pipework options including hammer, auxiliary, merged and low flow.





## A COMFORTABLE FAVOURITE.

JCB EXCAVATORS ARE DESIGNED AROUND THE OPERATOR. THAT'S GOOD FOR THEM BUT EVEN BETTER FOR YOU; AFTER ALL, GREAT COMFORT AND EASE OF USE EQUALS GREAT PRODUCTIVITY.

### Visibly better.

**1** A 70/30 front screen split gives JCB JS240/260s excellent front visibility. A clear view of the front right track provides easy, safe trench digging and manoeuvring.

An innovative low-level bonnet provides excellent rearward visibility.

### Comfortably in control.

**2** The JS240/260 creates a quieter working environment inside and out. JCB JS240/260 cabs use 6 viscous rubber mounts to minimise noise and vibration. The pressured cab keeps out dirt and dust.

**3** JCB's climate control option offers a precisely controlled cab temperature with fresh or recirculated air. Demisting/defrosting functions keep a JS240/260's front window clear. There's a spacious luggage tray behind the operator's seat.



Light, intuitive and smooth controls improve comfort and productivity. The JS240/260's joystick-mounted power boost button gives extra hydraulic power fast.









# LESS SERVICING, MORE SERVICE.

WE'VE DESIGNED JCB JS240/260 TO BE LOW MAINTENANCE AND EASILY SERVICEABLE. WHICH MAKES THEM AFFORDABLE, EFFICIENT AND HIGHLY PRODUCTIVE. HELPING YOU GET THE BEST SERVICE FROM YOUR MACHINE.



By using graphite impregnated bronze bushes, we've reduced the JS240/260's boom and dipper greasing intervals to 1000 hours for normal applications.



### Easy does it.

- 1 The air filter on a JS240/260 is easily accessible, and a double-element construction simplifies cleaning.
- 2 The filters on a JCB JS240/260 (engine oil, hydraulic oil and fuel) are centrally located for fast, easy servicing.

	SERVICE INTERVALS
Engine oil and oil filter	Every <b>500</b> hours
Hydraulic oil	Every <b>5000</b> hours
Hydraulic oil filter	Every <b>1 000</b> hours

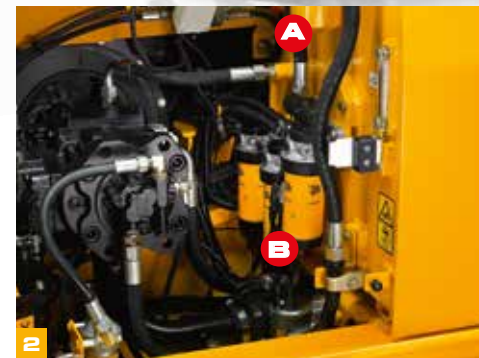

(A) Hydraulics oil filters (B) Fuel filters





**UNEARTHED: KEY FACT**  
 JCB JS240/260 grease points are centralised for safe and easy access to high level pivots.

JCB JS240/260 bonnets open and close easily with gas-assisted cylinders, and the service bays are large and wide for good access.

**Here to help.**

- 3 JCB's AMS automatically checks the engine oil and engine coolant level on machine start up.
- 4 Because they're mounted side by side on a JCB JS240/260, the engine radiator, hydraulic cooler and intercooler can be serviced individually yet cleaned easily.
- 5 Service your JCB JS240/260 with your local main dealer and our trained engineers can minimise downtime. Order genuine JCB parts online and, in 95% of cases, they'll be with you next day. For extra security and machine protection, opt for a package like JCB LiveLink remote machine monitoring.

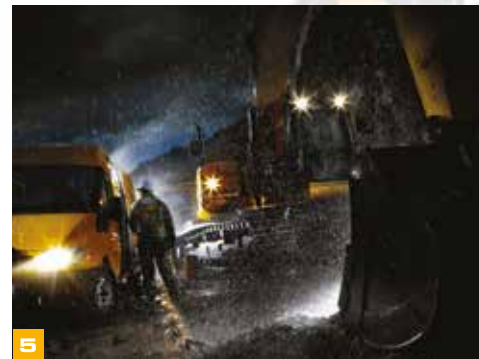



## THE SAFE CHOICE.

ON-SITE SAFETY IS CRUCIAL, SO WE'VE DESIGNED THE JS240/260 TO INCORPORATE AS MANY CUTTING EDGE SAFEGUARDS AS POSSIBLE. IN SHORT, YOUR OPERATORS ARE IN SAFE HANDS.



**1** JCB JS240/260 bonnet opens front-to-rear for easy and safe engine service access.

**2** For extra peace of mind, JCB JS240/260 cabs are available with an external rollover protection structure (ROPS). It's easy to fit JCB's FOPS (Falling Objects Protection Structure) to a JS240/260 cab, thanks to standard fitment mounting brackets.

**3** JCB's Safety Lever Lock fully isolates hydraulic functions to avoid unintended movements. Our start function means a JCB JS240/260 can only be started in a safe locked position.

**4** JCB JS240/260s have a large glass area and low bonnet line for superb visibility.

**5** A JCB JS240/260's steps and platforms have anti-slip punched steel plates for optimum grip, even in wet or icy conditions. Bolt-on plates have recessed bolts to reduce trip hazard.

**6** JCB's optional rear-view camera displays an uninterrupted backwards view on an in-cab colour monitor.

**7** Equip your JCB JS240/260 with a full set of side and rear view mirrors for all round visibility and safety compliance.

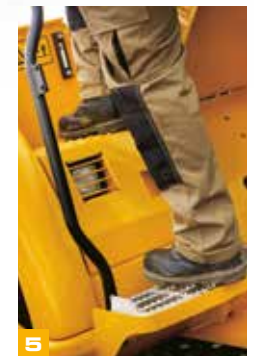







# LIVELINK, WORK SMARTER.

**JCB LIVELINK IS AN INNOVATIVE SOFTWARE SYSTEM THAT LETS YOU MONITOR AND MANAGE YOUR MACHINES REMOTELY – ONLINE, BY EMAIL OR BY MOBILE PHONE. LIVELINK GIVES YOU ACCESS TO A WHOLE HOST OF USEFUL DATA, INCLUDING MACHINE ALERTS, FUEL REPORTS\* AND EVENT HISTORY INFORMATION. ALL YOUR MACHINE INFORMATION IS HANDLED AT A SECURE DATA CENTRE FOR YOUR PEACE OF MIND.**

## Maintenance benefits

JCB LiveLink makes it easy to manage machine maintenance. Accurate hours monitoring and service alerts improve maintenance planning, and real-time location data helps you manage your fleet. You'll also have access to critical machine alerts and maintenance history records.



## Productivity and cost benefits

For ultimate productivity and cost-saving, JCB LiveLink provides information like idle time monitoring\* and machine fuel consumption\* to help reduce your fuel usage. Machine location information can improve fleet efficiency and you may even enjoy reduced insurance costs courtesy of the added security that LiveLink brings.

\* These features require an electronic engine.

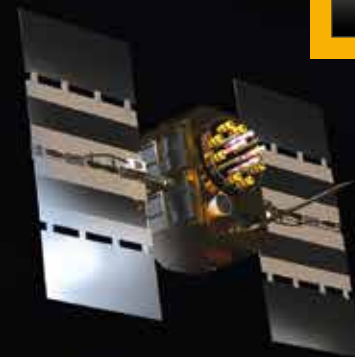

## Security benefits

Keep your machine operating safely with JCB LiveLink. Real-time geofencing alerts tell you when machines move out of predetermined operating zones, and real-time curfew alerts inform you if machines are being used when they're not supposed to be. Real time location information helps you store your machines in the safest places.





## VALUE ADDED.

JCB'S WORLDWIDE CUSTOMER SUPPORT IS FIRST CLASS. WHATEVER YOU NEED AND WHEREVER YOU ARE, WE'LL BE AVAILABLE QUICKLY AND EFFICIENTLY TO HELP MAKE SURE YOUR MACHINERY IS PERFORMING TO ITS FULL POTENTIAL.



1

1 Our Technical Support Service provides instant access to factory expertise, day or night, while our Finance and Insurance teams are always on hand to provide fast, flexible, competitive quotes.

2 JCB Assetcare offers comprehensive extended warranties and service agreements, as well as service-only or repair and maintenance contracts. Irrespective of what you opt for, our Maintenance teams around the world charge competitive labour rates, and offer non-obligation quotations as well as fast, efficient insurance repair work.



3

3 The global network of JCB Parts Centres is another model of efficiency; with 16 regional bases, we can deliver around 95% of all parts anywhere in the world within 24 hours. Our genuine JCB parts are designed to work in perfect harmony with your machine for optimum performance and productivity.

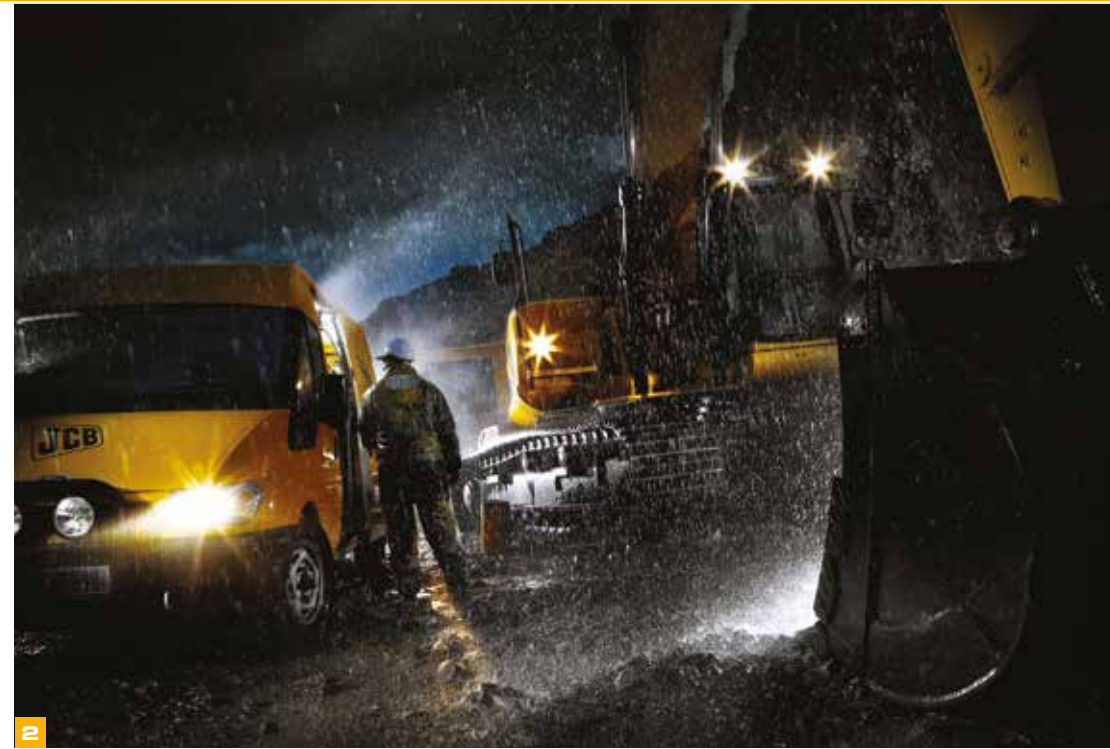

4

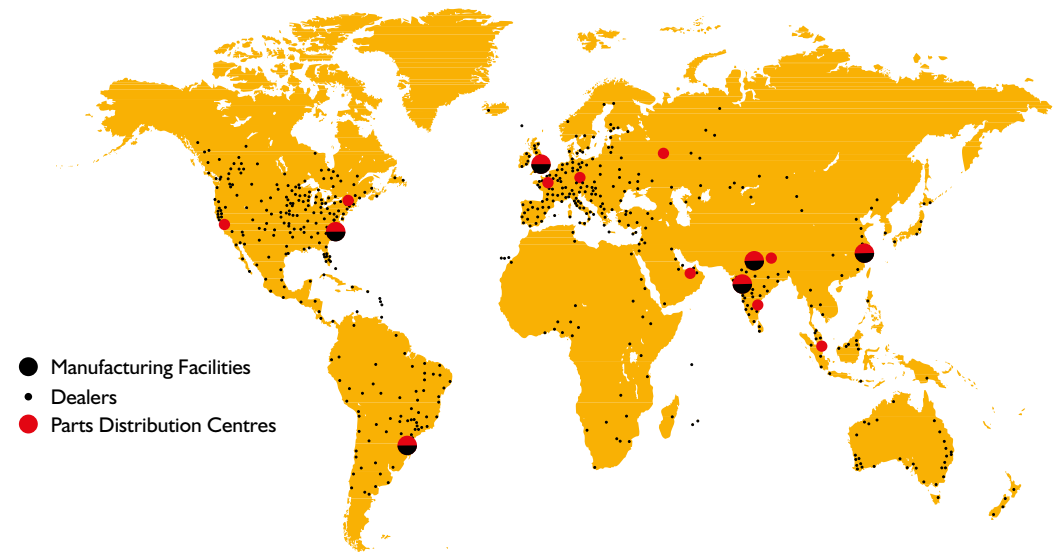

- Manufacturing Facilities
- Dealers
- Parts Distribution Centres



STATIC DIMENSIONS

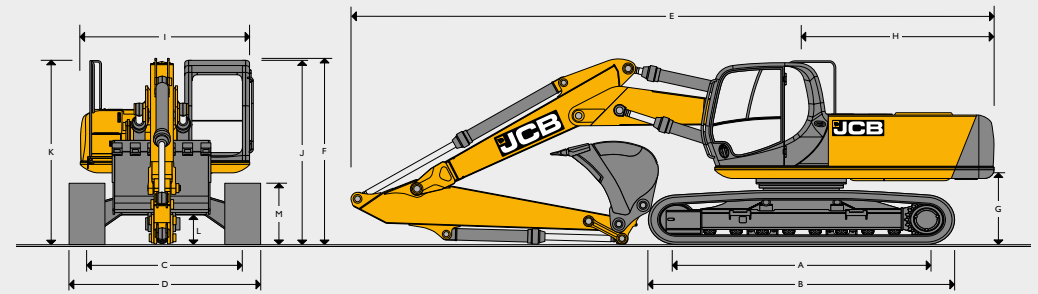
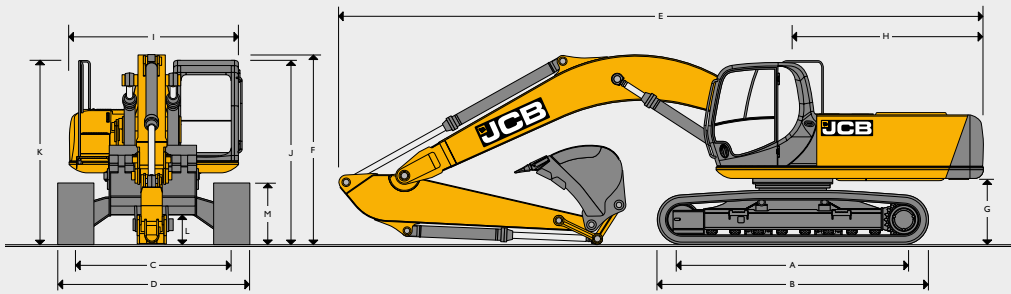

STATIC DIMENSIONS – MONOBOOM

Model		NLC	SC	LC
A	Track length on ground	mm 3840	3460	3840
B	Undercarriage overall length	mm 4640	4260	4640
C	Track gauge	mm 2390	2390	2590
D	Width over tracks (600 mm trackshoes)	mm 2990	2990	3190
D	Width over tracks (700 mm trackshoes)	mm 3090	3090	3290
D	Width over tracks (800 mm trackshoes)	mm 3290	3290	3490
D	Width over tracks (900 mm trackshoes)	mm 3290	3290	3490
G	Counterweight clearance	mm 1125	1125	1125
H	Tail swing radius	mm 3000	3000	3000
I	Overall width of superstructure	mm 2500	2500	2500
J	Height over cab	mm 2980	2980	2980
K	Height over grab rail	mm 3059	3059	3059
L	Ground clearance	mm 486	486	486
M	Track height	mm 940	940	940

STATIC DIMENSIONS – T.A.B.

Model		NLC	SC	LC
A	Track length on ground	mm 3840	3460	3840
B	Undercarriage overall length	mm 4640	4260	4640
C	Track gauge	mm 2390	2390	2590
D	Width over tracks (600 mm trackshoes)	mm 2990	2990	3190
D	Width over tracks (700 mm trackshoes)	mm 3090	3090	3290
D	Width over tracks (800 mm trackshoes)	mm 3190	3190	3390
D	Width over tracks (900 mm trackshoes)	mm 3290	3290	3490
G	Counterweight clearance	mm 1125	1125	1125
H	Tail swing radius	mm 3000	3000	3000
I	Overall width of superstructure	mm 2500	2500	2500
J	Height over cab	mm 2980	2980	2980
K	Height over grab rail	mm 3059	3059	3059
L	Ground clearance	mm 486	486	486
M	Track height	mm 940	940	940

Dipper lengths		2.00 m	2.44 m	3.09 m	3.53 m
E	Transport length with Monoboom	mm 10083	10060	9960	10010
F	Transport height with Monoboom	mm 3173	3230	3050	3220

Dipper lengths		2.00 m	2.44 m	3.09 m	3.53 m
E	Transport length with T.A.B.	mm 10090	10210	10170	10170
F	Transport height with T.A.B.	mm 3785	3270	3140	3290



ENGINE	
Model	Isuzu 4HK1X European Tier 4i emissions compliant.
Type	Water cooled, 4-stroke, 4-cylinder in-line, direct injection, turbocharged diesel.
Rated power (ISO 14899 (SAE J1995))	140 kW (188 hp) at 2000 rpm.
Piston displacement	5.193 litres.
Air filtration	Dry element with secondary safety element and in-cab warning indicator.
Cooling	Water cooled via large capacity radiator.
Starting system	24 Volt.
Batteries	2 x 12 Volt Heavy duty.
Alternator	24 volt 50 amp.
Refuelling pump	Electric type.

SWING SYSTEM	
Swing motor	Axial piston type.
Swing brake	Hydraulic braking plus automatic spring applied disc type parking brake.
Final drive	Planetary reduction.
Swing speed	10.6 rpm.
Swing gear	Large diameter, internally toothed fully sealed grease bath lubricated.
Swing lock	Multi-position switchable brake.

UNDERCARRIAGE		
Carriage options	SC-Standard, LC-Long Carriage and NLC-Narrow Long Carriage.	
Construction	Fully welded, 'X' frame type with central bellyguarding and sloping sidemembers with dirt relief holes under top rollers.	
Recovery point	Front and rear.	
Track type	Sealed and lubricated.	
Track shoe options	600 mm, 700 mm, 800 mm, 900 mm.	
Upper & lower rollers	Heat treated, sealed and lubricated.	
Track adjustment	Grease cylinder type.	
Track idler	Sealed and lubricated, with spring cushioned recoil.	
	<b>SC</b>	<b>NLC &amp; LC</b>
No. of track guides	2 per side	2 per side
No. of lower rollers	7 per side	9 per side
No. of upper rollers	2 per side	2 per side
No. of track shoes	47 per side	51 per side

TRACK DRIVE	
Type	Fully hydrostatic, three speed with autoshift.
Travel motors	Variable swash axial piston type, fully guarded within undercarriage frame.
Final drive	Planetary reduction, bolt-on sprockets.
Service brake	Hydraulic counter balance valve to prevent overspeeding on gradients.
Park brake	Disc type, spring applied, automatic hydraulic release.
Gradeability	70% (35 deg) continuous.
Travel speed	High – 5.6 km/h Mid – 3.3 km/h Low – 2.3 km/h
Tractive effort	197.1 kN

HYDRAULIC SYSTEM	
A variable flow load sensing system with flow on demand, variable power output and servo operated, multi-function open centre control.	
<b>Pumps</b>	
Main pumps	2 variable displacement axial piston type.
Maximum flow	2 x 229 L/min.
Servo pump	Gear type.
Maximum flow	20 L/min.
<b>Control valve</b>	
A combined four and five spool control valve with auxiliary service spool as standard. When required twin pump flow is combined to boom, dipper and bucket services for greater speed and efficiency.	
<b>Relief valve settings</b>	
Boom/Arm/Bucket	343 bar
With power boost	373 bar
Swing circuit	289 bar
Travel circuit	343 bar
Pilot control	40 bar

Hydraulic cylinders	
Double acting type, with bolt-up end caps and hardened steel bearing bushes. End cushioning is fitted as standard on boom, dipper and bucket rams.	

Filtration	
The hydraulic components are protected by the highest standard of filtration to ensure long hydraulic fluid and component life.	
In tank	150 micron, suction strainer.
Main return line	10 micron, fibreform element.
Plexus bypass line	1.5 micron, paper element.
Pilot line	10 micron, paper element.
Hydraulic hammer return	10 micron, reinforced microform element.

Cooling	
Worldwide cooling is provided via a full return line air blast cooler as part of a single face cooling pack, in conjunction with the engine water cooler. Intercooler.	

EXCAVATOR END – MONOBOOM	
Monoboom available along with a choice of dipper lengths to suit the requirements of reach, dig-depth, loadover height, tearouts and site versatility. Reserve strength is built into the fully welded structures for hydraulic hammer and other arduous operations. Fabricated bucket tipping links are provided with a choice of lift points. Strong, durable construction, large cross sections and multi-plate fabrications to withstand high stress applications. The 5.85m boom is designed to ensure the optimum digging envelope when matched with the three dipper lengths. Low maintenance bronze alloy bushes with graphite plugs are fitted to boom base and boom to dipper pivots resulting in 1000 hour greasing intervals at these points.	

EXCAVATOR END – T.A.B	
Triple articulated boom available along with a choice of dipper lengths to suit the requirements of reach, dig-depth, loadover height, tearouts and site versatility. Reserve strength is built into the fully welded structures for hydraulic hammer and other arduous operations. Fabricated bucket tipping links are provided with a choice of lift points. Strong, durable construction, large cross sections and multi-plate fabrications to withstand high stress applications. The boom is designed to ensure the optimum digging envelope when matched with the three dipper lengths.	



**CAB**

Excellent digging, loading and positioning visibility results from the careful design of front, side and roof lights. All screens are tinted to improve in cab conditions. Fully opening front screen is very smooth to operate and the lower screen is stored in rear of cab. Fresh air ventilation available from opening door window, opening slot in front screen and fully opening front screen. Parallelogram wash wiper for upper screen ensuring good wiped area for maximum visibility. Wiper motor is fitted in the left hand side of the roof screen so as not to affect bucket visibility when loading. Optional lower screen wiper available. Fresh air ventilation and heater with windscreen demister. Infinitely variable blower speed, temperature and recirculation control. Optional climate control. Fully adjustable deluxe suspension seat with arm rest adjustment and backrest recline. Radio with digital tuner fitted into the roof lining for maximum protection. Conveniently placed radio mute button incorporated into lower console. 12V power point and mobile phone holder built into the right hand console. Courtesy light can be operated from ground level and is illuminated for five minutes or until switched off improving operator access at night. Cab mounted roller blind protects operator from suns' glare.

**AMS – ADVANCED MANAGEMENT SYSTEM**

Four selectable working modes link the operators control movements with the engine and hydraulic systems to maximise productivity and efficiency

<b>A (Auto)</b>	Up to 100% engine power and 100% flow. Gives variable power and speed depending on the operator's input, matching the demand for output and efficiency to the job. Power boost is automatically activated in this mode should hard conditions be encountered. Auto idle cuts in after a period of inactivity (between 5 and 30 seconds as set by the operator).
<b>E (Economy)</b>	80% engine power. 95% of hydraulic flow maximises economy while maintaining excellent output.
<b>P (Precision)</b>	55% engine power. 90% of hydraulic flow for fine control of grading operations.
<b>L (Lifting)</b>	55% engine power. 63% of hydraulic flow with permanent power boost for maximum lifting power and control.

The Auto mode allows the AMS processor to select the optimum operational performance to match the demands of the job while the three alternative modes give precise matching of application when specific tasks are undertaken.

The adjustable position monitor mounted on the front right hand pillar of the cab gives the operator a constant read out of mode, tracking range, operating temperature and a host of other information, while retaining excellent visibility of the monitor and the job being carried out.

The required flow for hammer applications can be set and stored in the AMS memory and is automatically activated whenever the hammer pedal is depressed.

A maintenance indicator warns of imminent service needs, and all servicing and basic checks can be carried out using only the in cab display.

**CONTROLS**

Excavator	All servo lever operated to ISO control pattern, independently adjustable to the seat.
Tracks	Individually servo operated by foot pedal or hand lever. Speed selection via joystick button.
Auxiliary	Via servo operated foot pedal.
Control isolation	Via gate lock lever at cab entrance or panel switch.
Engine speed	Dial type throttle control plus servo lever mounted one-touch idle control or separate selectable auto-idle with adjustable time delay using AMS.
Engine stop	Ignition key operated and separate shut-down button.
Horn	Operated via servo lever mounted button.

**STANDARD EQUIPMENT FOR XTRA DUTY BUILDS**

Cab cage (FOPS level II); Visibowl pre-cleaner; Reinforced dipper; Reinforced bucket links; Impact buffer around upper structure; Heavy-duty 10mm underguards and trackmotor covers; Reinforced front light protection.

**SERVICE CAPACITIES**

Fuel tank	litres	343
Engine coolant	litres	31
Engine oil	litres	25.9
Swing reduction gear	litres	6
Track reduction gear (each side)	litres	4.7
Hydraulic system	litres	241
Hydraulic tank	litres	120

**WEIGHTS AND GROUND BEARING PRESSURES**

Figures include 1.14m<sup>3</sup> bucket, operator and full fuel tank.

Undercarriage and shoe width	Weight/Ground bearing pressure	
	JS240/JS260 Monoboom	JS240/JS260 T.A.B.
NLC 600 mm	26095 kg	27280 kg
SC 600 mm	25539 kg	26724 kg
LC 700 mm	26446 kg	27632 kg

**GENERAL PURPOSE EXCAVATOR BUCKETS**

All buckets are JCB – Esco type fully welded steel, with sealed, hardened steel pivot pins and replaceable wear parts.

Max. width	Capacity (SAE heaped)	Weight
900 mm	0.77 m <sup>3</sup>	775 kg
1100 mm	1.01 m <sup>3</sup>	857 kg
1200 mm	1.13 m <sup>3</sup>	898 kg
1500 mm	1.35 m <sup>3</sup>	936 kg
1600 mm	1.46 m <sup>3</sup>	973 kg

**STANDARD/OPTIONAL EQUIPMENT**

**Standard Equipment:** Engine fan guard; Cold start pre-heat; Auto engine warm up; Double element air cleaner; Electric refuelling pump; Heavy duty alternator; Electrics isolator; Heavy duty batteries; Cab & engine soundproofing; Cab heater and screen demister; Tinted glass; Interior light; Coat hook; Cigarette lighter; Ashtray; Operator's storage shelf; Removable floormat; Windscreen wash/wipe; Plug-in power socket; Automatic power boost; Auto-idle; One-touch engine speed control; Hydraulic cushion control; Boom/swing priority switch; Plexus hydraulic oil filtration; HSP pressure test points; Auxiliary pipework mounting brackets; Work lights – boom and mainframe mounted; Undercarriage belly guarding; Upper structure under covers; Swing system cover; Twin track guides; External mirrors; Handrail and non slip walk ways; Quick connect engine oil drain pipe; Front screen blind; Quick connect fuel tank drain pipe; Hinged engine under cover; Remote filter system.

**Optional Equipment:** Hose burst check valves and overload warning system; Tipping link mounted lift points; General purpose buckets; Ditch/grading buckets; Quickhitch buckets; Hydraulic hammers; Auxiliary pipework (full and low flow); Climate control; Cab mounted and rear work lights; Rotating beacon; Rain guard; Biodegradable oil; Air suspension seat with heated pad and lumbar support adjustment; Lower screen wiper; Radio; High and low temperature hydraulic oil option.



**WORKING RANGE – NLC/SC/LC MONOBOOM**

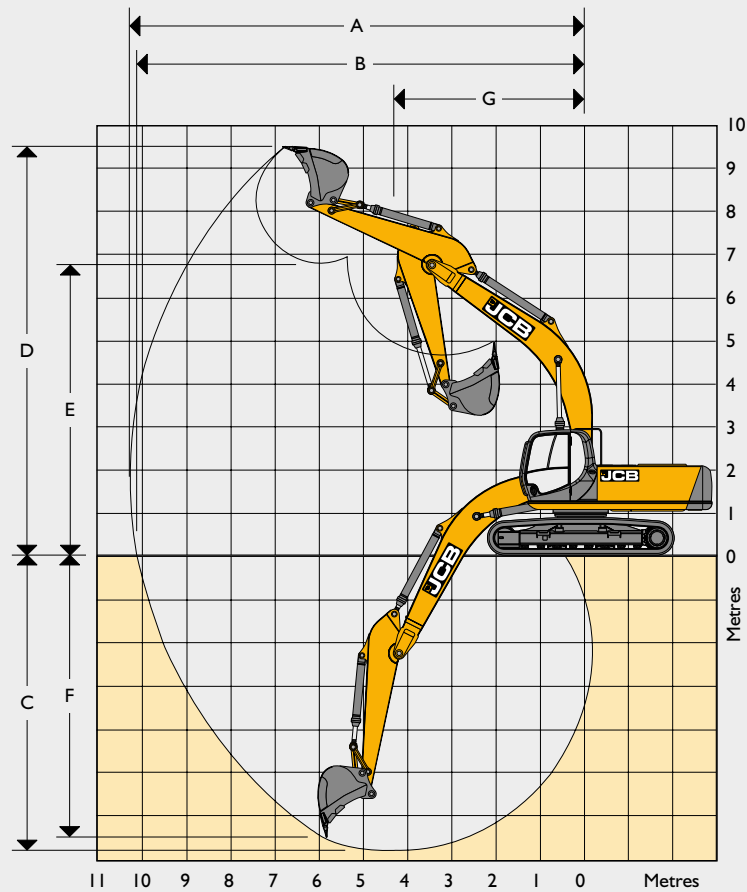

**WORKING RANGE – NLC/SC/LC T.A.B.**

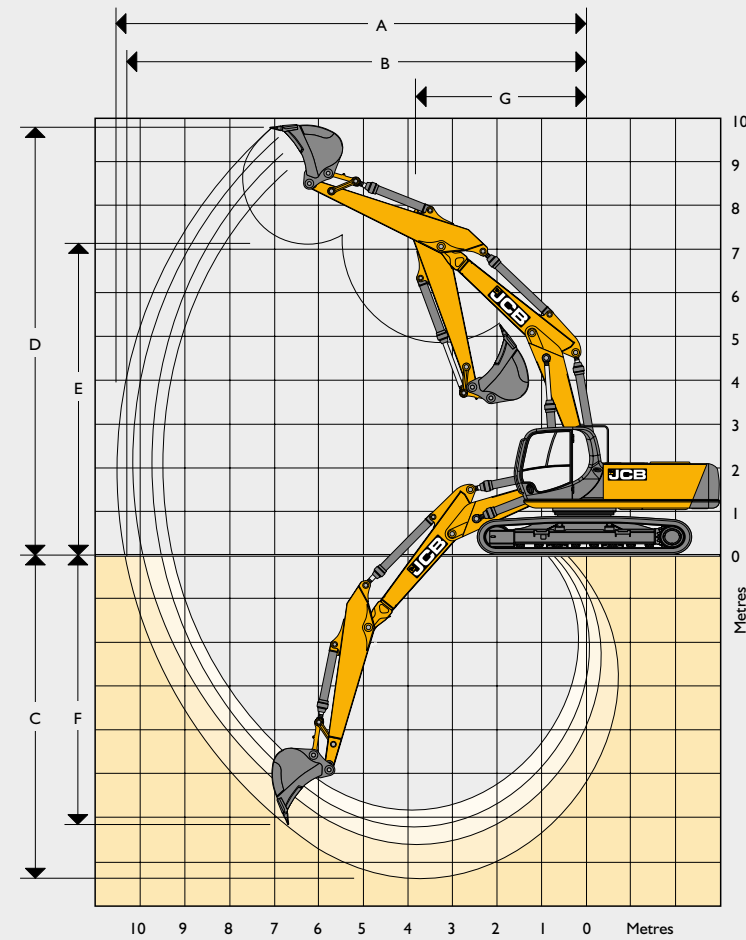











		5.85m Monoboom				
Dipper length		2.00m	2.44m	3.09m	3.53m	
A	Maximum digging reach	m	9.19	9.64	10.27	10.69
B	Maximum digging reach (on ground)	m	8.99	9.45	10.01	10.52
C	Maximum digging depth	m	5.72	6.14	6.79	7.23
D	Maximum digging height	m	8.84	9.23	9.62	9.85
E	Maximum dumping height	m	6.15	6.47	6.83	7.05
F	Maximum vertical wall cut depth	m	4.51	5.35	6.21	6.67
G	Minimum swing radius	m	4.02	3.99	3.87	3.88
	Bucket rotation	degrees	180°	180°	180°	180°
	Max. Dipper tearout (ISO 6015)	kgf	18272	15484	12248	11198
	Max. Bucket tearout (ISO 6015)	kgf	19574	19574	19574	19574















		6.24m T.A.B.				
Dipper length		2.00m	2.44m	3.09m	3.53m	
A	Maximum digging reach	m	9.78	10.22	10.87	11.29
B	Maximum digging reach (on ground)	m	9.59	10.05	10.70	11.13
C	Maximum digging depth	m	5.85	6.30	6.95	7.40
D	Maximum digging height	m	10.81	11.25	11.79	12.12
E	Maximum dumping height	m	7.70	8.15	8.70	8.93
F	Maximum vertical wall cut depth	m	4.47	5.11	5.79	6.26
G	Minimum swing radius	m	3.06	3.23	2.82	2.89
	Bucket rotation	degrees	180°	180°	180°	180°
	Max. Dipper tearout (ISO 6015)	kgf	18272	15484	12248	11198
	Max. Bucket tearout (ISO 6015)	kgf	19574	19574	19574	19574

















**LIFT CAPACITIES – Dipper length: 2.01m, 5.85m Monoboom, Trackshoes: 600mm, No bucket.** **JS240/JS260 NLC MONO**

Reach	Reach from Swing Centre															
	1.5m		3m		4.5m		6m		7.5m		9m		Max. Reach			
																
Load Point Ht.	kg	kg	kg	kg	kg	kg	kg	kg	kg	kg	kg	kg	kg	kg	mm	
6m							7380*	7080*						7300*	6180	6515
4.5m					9700*	9700*	7870*	6830*						6210*	4980	7655
3m					11660*	9520*	8670*	6470	7340*	4730				7260*	4590	7647
1.5m							9350*	6160	7580*	4590				7390*	4420	7719
0m					12860*	8780	9590*	5990						7550*	4520	7491
- 1.5m			13550*	13550*	12060*	8820	9180*	5970						7690*	5000	6931
- 3m			12970*	12970*	10280*	9040								7620*	6240	5945

**LIFT CAPACITIES – Dipper length: 2.43m, 5.85m Monoboom, Trackshoes: 600mm, No bucket.** **JS240/JS260 NLC MONO**

Reach	Reach from Swing Centre															
	1.5m		3m		4.5m		6m		7.5m		9m		Max. Reach			
																
Load Point Ht.	kg	kg	kg	kg	kg	kg	kg	kg	kg	kg	kg	kg	kg	kg	mm	
6m							6890*	6890*						6760*	5490	7044
4.5m					9050*	9050*	7470*	6890*	6750*	9890				6710*	4640	7741
3m					11060*	9700*	8340*	6520	7060*	4740				6770*	4210	8101
1.5m					12540*	9030	9120*	6170	7410*	4570				6800*	4060	8170
0m					12900*	8760	9510*	5960	7530*	4460				6990*	4140	7955
- 1.5m			12320*	12320*	12370*	8730	9310*	5900						7180*	4520	7431
- 3m			14400*	1440*	10910*	8890	8160*	6010						7180*	5440	6522
- 4.5m					7660*	7660*								6570*	6570*	5018

**LIFT CAPACITIES – Dipper length: 3.09m, 5.85m Monoboom, Trackshoes: 600mm, No bucket.** **JS240/JS260 NLC MONO**



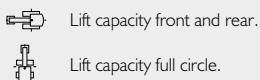











Reach	Reach from Swing Centre															
	1.5m		3m		4.5m		6m		7.5m		9m		Max. Reach			
																
Load Point Ht.	kg	kg	kg	kg	kg	kg	kg	kg	kg	kg	kg	kg	kg	kg	mm	
6m									5450*	5070*				4080*	4080*	7777
4.5m							6830*	6830*	6210*	4970				4020*	4020*	8412
3m					10100*	10030*	7790*	6640*	6650*	4790				4100*	3760*	8744
1.5m					11930*	9230	8730*	6250	7120*	4590				4330*	3630	8807
0m			6590*	6590*	12780*	8800	9330*	5970	7420*	4440				4760*	3690	8608
- 1.5m	7240*	7240*	11480*	11480*	12680*	8670	9410*	5840	7350*	4370				5520*	3960	8127
- 3m	12360*	12360*	16260*	16260*	11680*	8740	8750*	5870						6670*	4590	7308
- 4.5m			12720*	12720*	9390*	9020	6510*	6140						6490*	6130	6009

















- Notes:**
1. For lifting capacity including bucket, subtract total weight of bucket or bucket and quickhitch from above values.
  2. Lifting capacities are based on ISO 10567, that is: 75% of minimum tipping load or 87% of hydraulic lift capacity, whichever is the less. Lifting capacities marked\* are based on hydraulic capacity.
  3. Lift capacities assume that the machine is on firm, level ground.
  4. Lift capacities may be limited by local regulations. Please refer to your dealer.

















**LIFT CAPACITIES – Dipper length: 3.52m, 5.85m Monoboom, Trackshoes: 600mm, No bucket.** **JS240/JS260 NLC MONO**

Reach	Reach from Swing Centre															
	1.5m		3m		4.5m		6m		7.5m		9m		Max. Reach			
																
Load Point Ht.	kg	kg	kg	kg	kg	kg	kg	kg	kg	kg	kg	kg	kg	kg	mm	
7.5m														3780*	3780*	7289
6m									5570*	5130				3560*	3560*	8247
4.5m							6350*	6350*	5830*	5010	4060*	3890	3500*	3500*	8848	
3m			14600*	14600*	9360*	9360*	7350*	6700*	6320*	4800	4520*	3590	3570*	3480	9164	
1.5m					11350*	9330	8360*	6270	6850*	4580	5190*	3490	3750*	3360	9224	
0m			7210*	7210*	12490*	8790	9090*	5940	7250*	4390	4390*	3410	4090*	3390	9035	
- 1.5m	6680*	6680*	10890*	10890*	12680*	8570	9340*	5770	7330*	4290			4670*	3610	8578	
- 3m	10940*	10940*	16190*	16190*	11980*	8590	8940*	5750	6780*	4320			5740*	4120	7807	
- 4.5m			14080*	14080*	10150*	8810	7420*	5920					6270*	5270	6609	

**LIFT CAPACITIES – Dipper length: 2.01m, 5.85m Monoboom, Trackshoes: 600mm, No bucket.** **JS240/JS260 SC MONO**

Reach	Reach from Swing Centre														
	1.5m		3m		4.5m		6m		7.5m		9m		Max. Reach		
															
Load Point Ht.	kg	kg	kg	kg	kg	kg	kg	kg	kg	kg	kg	kg	kg	kg	mm
6m							7380*	6970					7300*	6080	6515
4.5m					9700*	9700*	7870*	6720					7210*	5010	7264
3m					11660*	9360	8670*	6360	6820	4650			6620	4510	7647
1.5m							9150	6050	6670	4510			6400	4340	7719
0m					12860*	8630	8950	5880	6690	4780			6600	4440	7491
- 1.5m			13550*	13550*	12060*	8670	8940	5860					7350	4910	6931
- 3m			12970*	12970*	10280*	8880							7620*	6130	5945





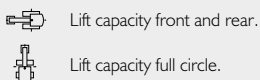









**LIFT CAPACITIES – Dipper length: 2.43m, 5.85m Monoboom, Trackshoes: 600mm, No bucket.** **JS240/JS260 SC MONO**

Reach	Reach from Swing Centre														
	1.5m		3m		4.5m		6m		7.5m		9m		Max. Reach		
															
Load Point Ht.	kg	kg	kg	kg	kg	kg	kg	kg	kg	kg	kg	kg	kg	kg	mm
6m							6890*	6890*					6780*	5400	7044
4.5m					9050*	9050*	7470*	6790	6750*	4810			6640	4560	7741
3m					11060*	9540	8340*	6410	6830	4660			6070	4140	8101
1.5m					12540*	8870	9120*	6070	6650	4490			5880	3990	8170
0m					12900*	8600	8930	5850	6530	4380			6040	4070	7955
- 1.5m			12320*	12320*	12370*	8580	8870	5790					6620	4440	7431
- 3m			14400*	14400*	10910*	8740	8160*	5910					7180*	5340	6522
- 4.5m					7660*	7660*							6570*	6570*	5018















- Notes:**
1. For lifting capacity including bucket, subtract total weight of bucket or bucket and quickhitch from above values.
  2. Lifting capacities are based on ISO 10567, that is: 75% of minimum tipping load or 87% of hydraulic lift capacity, whichever is the less. Lifting capacities marked\* are based on hydraulic capacity.
  3. Lift capacities assume that the machine is on firm, level ground.
  4. Lift capacities may be limited by local regulations. Please refer to your dealer.











**LIFT CAPACITIES – Dipper length: 3.09m, 5.85m Monoboom, Trackshoes: 600mm, No bucket. JS240/JS260 SC MONO**

Reach	Reach from Swing Centre														
	1.5m		3m		4.5m		6m		7.5m		9m		Max. Reach		
															
Load Point Ht.	kg	kg	kg	kg	kg	kg	kg	kg	kg	kg	kg	kg	kg	kg	mm
6m									5450*	4990			4080*	4080*	7777
4.5m							6830*	6830*	6210*	4890			4020*	4020*	8412
3m					10100*	9870	7790*	6530	6650*	4700			4100*	3700	8744
1.5m					11920*	9080	8730*	6140	6670	4510			4330*	3570	8807
0m			6590*	6590*	12780*	8640	8950	5860	6510	4350			4760*	3620	8608
- 1.5m	7240*	7240*	11480*	11480*	12680*	8510	8810	5740	6440	4290			5520*	3880	8127
- 3m	12360*	12360*	16260*	16260*	11680*	8580	8750*	5770					6670*	4510	7308
- 4.5m			12720*	12720*	9390*	8870	6510*	6030					6490*	6020	6009

**LIFT CAPACITIES – Dipper length: 3.52m, 5.85m Monoboom, Trackshoes: 600mm, No bucket. JS240/JS260 SC MONO**

Reach	Reach from Swing Centre														
	1.5m		3m		4.5m		6m		7.5m		9m		Max. Reach		
															
Load Point Ht.	kg	kg	kg	kg	kg	kg	kg	kg	kg	kg	kg	kg	kg	kg	mm
7.5m													3780*	3780*	7289
6m									5570*	5050			3560*	3560*	8247
4.5m							6350*	6350*	5830*	4930			3500*	3500*	8848
3m			14600*	14600*	9360*	9360*	7350*	6590	6320*	4720	4520*	3520	3570*	3410	9164
1.5m					11350*	9180	8360*	6160	6670	4490	5080	3420	3750*	3290	9224
0m			7210*	7210*	12490*	8630	8930	5840	6470	4310	4390*	3350	4090*	3330	9035
- 1.5m	6680*	6680*	10890*	10890*	12680*	8410	8740	5660	6362	4210			4670*	3540	8578
- 3m	10940*	10940*	16190*	16120	11980*	8430	8720	5650	6390	4240			5740*	4040	7807
- 4.5m			14080*	14080*	10150*	8650	7420*	5820					6270*	5170	6609

**LIFT CAPACITIES – Dipper length: 2.01m, 5.85m Monoboom, Trackshoes: 700mm, No bucket. JS240/JS260 LC MONO**



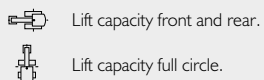











Reach	Reach from Swing Centre														
	1.5m		3m		4.5m		6m		7.5m		9m		Max. Reach		
															
Load Point Ht.	kg	kg	kg	kg	kg	kg	kg	kg	kg	kg	kg	kg	kg	kg	mm
6m							7380*	7380*					7300*	6750	6515
4.5m					9700*	9700*	7870*	7480					7210*	5580	7264
3m					11660*	10560	8670*	7110	7340*	5190			7260*	5040	7647
1.5m							9350*	6790	7580*	5050			7390*	4850	7719
0m					12860*	9800	9590*	6620					7550*	4980	7491
- 1.5m			13550*	13550*	12060*	9840	9180*	6600					7690*	5510	6931
- 3m			12970*	12970*	10280*	10060*							7620*	6880	5945

















- Notes:**
1. For lifting capacity including bucket, subtract total weight of bucket or bucket and quickhitch from above values.
  2. Lifting capacities are based on ISO 10567, that is: 75% of minimum tipping load or 87% of hydraulic lift capacity, whichever is the less. Lifting capacities marked\* are based on hydraulic capacity.
  3. Lift capacities assume that the machine is on firm, level ground.
  4. Lift capacities may be limited by local regulations. Please refer to your dealer.

















**LIFT CAPACITIES – Dipper length: 2.43m, 5.85m Monoboom, Trackshoes: 700mm, No bucket.** **JS240/JS260 LC MONO**

Reach	Reach from Swing Centre														
	1.5m		3m		4.5m		6m		7.5m		9m		Max. Reach		
															
Load Point Ht.	kg	kg	kg	kg	kg	kg	kg	kg	kg	kg	kg	kg	kg	kg	mm
6m							6890*	6890*					6760*	6000	7044
4.5m					9050*	9050*	7470*	7470*	6750*	5350			6710*	5080	7741
3m					11060*	10750	8340*	7160	7060*	5200			6770*	4620	8101
1.5m					12540*	10060	9120*	6810	7410*	5030			6880	4470	8170
0m					12900*	9780	9510*	6590	7530*	4920			7040*	4560	7955
- 1.5m			12320*	12320*	12370*	9760	9310*	6530					7180*	4980	7431
- 3m			14400*	14400*	10910*	9920	8160*	6650					7180*	6000	6522
- 4.5m					7660*	7660*							6570*	6570*	5018

**LIFT CAPACITIES – Dipper length: 3.09m, 5.85m Monoboom, Trackshoes: 700mm, No bucket.** **JS240/JS260 LC MONO**

Reach	Reach from Swing Centre														
	1.5m		3m		4.5m		6m		7.5m		9m		Max. Reach		
															
Load Point Ht.	kg	kg	kg	kg	kg	kg	kg	kg	kg	kg	kg	kg	kg	kg	mm
6m									5450*	5450*			4080*	4080*	7777
4.5m							6830*	6830*	6210*	5440			4020*	4020*	8412
3m					10100*	10100*	7790*	7290	6650*	5250			4100*	4100*	8744
1.5m					11920*	10270	8730*	6890	7120*	5050			4330*	4000	8807
0m			6590*	6590*	12780*	9820	9330*	6610	7420*	4890			4760*	4060	8608
- 1.5m	7240*	7240*	11480*	11480*	12680*	9690	9410*	6480	7350*	4830			5520*	4370	8127
- 3m	12360*	12360*	16260*	16260*	11680*	9760	8750*	6510					6670*	5070	7308
- 4.5m			12720*	12720*	9390*	9390*	6510*	6510*					6490*	4690*	6009





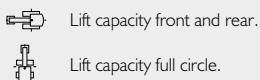









**LIFT CAPACITIES – Dipper length: 3.52m, 5.85m Monoboom, Trackshoes: 700mm, No bucket.** **JS240/JS260 LC MONO**

Reach	Reach from Swing Centre														
	1.5m		3m		4.5m		6m		7.5m		9m		Max. Reach		
															
Load Point Ht.	kg	kg	kg	kg	kg	kg	kg	kg	kg	kg	kg	kg	kg	kg	mm
7.5m													3780*	3780*	7289
6m									5570*	5570*			3560*	3560*	8247
4.5m							6350*	6350*	5830*	5470			3500*	3500*	8848
3m			14600*	14600*	9360*	9360*	7350*	7350	6320*	5260	4520*	3950	3570*	3570*	9164
1.5m					11350*	10380	8360*	6910	6850*	5030	5190*	3850	3752*	3700	9224
0m			7210*	7210*	12490*	9810	9090*	6580	7250*	4850	4390*	3770	4090*	3750	9035
- 1.5m	6680*	6680*	10890*	10890*	12680*	9590	9340*	6400	7330*	4750			4670*	3990	8578
- 3m	10940*	10940*	16190*	16190*	11980*	9610	8940*	6390	6780*	4770			5740*	4550	7807
- 4.5m			14080*	14080*	10150*	9830*	7420*	6560					6270*	5820	6609







- Notes:**
1. For lifting capacity including bucket, subtract total weight of bucket or bucket and quickhitch from above values.
  2. Lifting capacities are based on ISO 10567, that is: 75% of minimum tipping load or 87% of hydraulic lift capacity, whichever is the less. Lifting capacities marked\* are based on hydraulic capacity.
  3. Lift capacities assume that the machine is on firm, level ground.
  4. Lift capacities may be limited by local regulations. Please refer to your dealer.















**LIFT CAPACITIES – Dipper length: 2.01m, 6.24m T.A.Boom, Trackshoes: 600mm, No bucket.** **JS240/JS260 NLC T.A.B.**

Reach	Reach from Swing Centre														
	1.5m		3m		4.5m		6m		7.5m		9m		Max. Reach		
															
Load Point Ht.	kg	kg	kg	kg	kg	kg	kg	kg	kg	kg	kg	kg	kg	kg	mm
7.5m					10040*	10040*							8680*	7280	5865
6m			14720*	14720*	10550*	10550*	8540*	6950					7710*	5340	7024
4.5m					11680*	9960	8900*	6590	7360*	4690			7180*	4470	7723
3m							9250*	6150	7390*	4520			6810*	4040	8084
1.5m							9230*	5810	7240*	4350			6460*	3890	8152
0m							8600*	5640	6660*	4260			6030*	3980	7937
- 1.5m					8530*	8420	7250*	5650					5340*	4370	7411
- 3m							4810*	4810*					4650*	4650*	6130

**LIFT CAPACITIES – Dipper length: 2.43m, 6.24m T.A.Boom, Trackshoes: 600mm, No bucket.** **JS240/JS260 NLC T.A.B.**

Reach	Reach from Swing Centre														
	1.5m		3m		4.5m		6m		7.5m		9m		Max. Reach		
															
Load Point Ht.	kg	kg	kg	kg	kg	kg	kg	kg	kg	kg	kg	kg	kg	kg	mm
9m					9950*	9950*							9250*	9250*	4724
7.5m					9530*	9530*	8150*	7170					7890*	6250	6475
6m					10080*	10080*	8230*	7050	7150*	4840			7130*	4790	7540
4.5m					11240*	10220	8660*	6680	7190*	4740			6680*	4080	8194
3m					12360*	9120	9100*	6210	7300*	4530			6360	3720	8534
1.5m							9220*	5830	7250*	4330			6050*	3590	8559
0m					11170*	8250	8780*	5610	6840*	4210			5680*	3650	8395
- 1.5m					9370*	8300	7650*	5570	5770*	4200			5100*	3960	7901
- 3m					6770*	6770*	5230*	5600*					4060*	4060*	7055

**LIFT CAPACITIES – Dipper length: 3.09m, 6.24m T.A.Boom, Trackshoes: 600mm, No bucket.** **JS240/JS260 NLC T.A.B.**

Reach	Reach from Swing Centre														
	1.5m		3m		4.5m		6m		7.5m		9m		Max. Reach		
															
Load Point Ht.	kg	kg	kg	kg	kg	kg	kg	kg	kg	kg	kg	kg	kg	kg	mm
7.5m							7170*	7170*					4870*	4870*	7292
6m					7400*	7400*	7750*	7240	6760*	4990			4610*	4180	8250
4.5m			15500*	15500*	10530*	10530*	8260*	6850	6920*	4830			4550*	3630	8851
3m					11880*	9530	8830*	6360	7140*	4590	5780*	3440	4630*	3340	9167
1.5m					12460*	8660	9160*	5910	7230*	4360	5780	3340	4880*	3220	9227
0m					11880*	8270	8980*	5620	7020*	4190	5340*	3280	5290*	3260	9038
- 1.5m			8300*	8300*	10430*	8200	8170*	5510	6310*	4120			4860*	3490	8581
- 3m					8180*	8180*	6570*	5560	4700*	4190			4130*	4010	7810

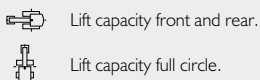















- Notes:**
1. For lifting capacity including bucket, subtract total weight of bucket or bucket and quickhitch from above values.
  2. Lifting capacities are based on ISO 10567, that is: 75% of minimum tipping load or 87% of hydraulic lift capacity, whichever is the less. Lifting capacities marked\* are based on hydraulic capacity.
  3. Lift capacities assume that the machine is on firm, level ground.
  4. Lift capacities may be limited by local regulations. Please refer to your dealer.















**LIFT CAPACITIES – Dipper length: 3.52m, 6.24m T.A.Boom, Trackshoes: 600mm, No bucket. JS240/JS260 NLC T.A.B.**

Reach	Reach from Swing Centre														
	1.5m		3m		4.5m		6m		7.5m		9m		Max. Reach		
															
Load Point Ht.	kg	kg	kg	kg	kg	kg	kg	kg	kg	kg	kg	kg	kg	kg	mm
9m							5770*	5770*					4710*	4710*	6453
7.5m							6280*	6280*	5210*	5080			4220*	4220*	7819
6m							6590*	6590*	6360*	5060			4010*	3810	8718
4.5m			8940*	8990*	8380*	8380*	7920*	6950	6690*	4870	5190*	3550	3960*	3340	9288
3m					11420*	9760	8550*	6440	6950*	4610	5860*	3440	4030*	3080	9589
1.5m					12290*	8770	9000*	5940	7120*	4350	5760*	3310	4220*	2970	9647
0m			4250*	4250*	12070*	8240	8980*	5590	7020*	4140	5530*	3200	4560*	3000	9466
- 1.5m			8000*	8000*	10910*	8080	8370*	5430	6990*	4040	4700*	3200	4650*	3190	9032
- 3m			10620*	10620*	8910*	8150	7030*	5430	5260*	4060			4060*	3610	9304
- 4.5m							4620*	4620*					4230*	4230*	6351

**LIFT CAPACITIES – Dipper length: 2.01m, 6.24m T.A.Boom, Trackshoes: 600mm, No bucket. JS240/JS260 SC T.A.B.**

Reach	Reach from Swing Centre														
	1.5m		3m		4.5m		6m		7.5m		9m		Max. Reach		
															
Load Point Ht.	kg	kg	kg	kg	kg	kg	kg	kg	kg	kg	kg	kg	kg	kg	mm
7.5m					10040*	10040*							8680*	7170	5865
6m			14720*	14720*	10550*	10550*	8540*	6840					7710*	5250	7024
4.5m					11680*	9810	8900*	6480	6860	4610			6530	4390	7723
3m							9240	6040	6660	4440			5950	3970	8084
1.5m							8860	5700	6480	4270			5770	3820	8152
0m							8600*	5530	6380	4180			5930	3900	7937
- 1.5m					8530*	8270	7250*	5540					5340*	4280	7411
- 3m							4810*	4810*					4650*	4650*	6293





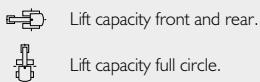



**LIFT CAPACITIES – Dipper length: 2.43m, 6.24m T.A.Boom, Trackshoes: 600mm, No bucket. JS240/JS260 SC T.A.B.**

Reach	Reach from Swing Centre														
	1.5m		3m		4.5m		6m		7.5m		9m		Max. Reach		
															
Load Point Ht.	kg	kg	kg	kg	kg	kg	kg	kg	kg	kg	kg	kg	kg	kg	mm
9m					9950*	9950*							9250*	9250*	4724
7.5m					9530*	9530*	8150*	7060					7890*	6150	6475
6m					10080*	10080*	8230*	6940	7020	4750			6950	4710	7540
4.5m					11240*	10060	8660*	6570	6910	4660			5960	4000	8194
3m					12360*	8970	9100*	6110	6690	4450			5480	3650	8534
1.5m							8890	5720	6470	4250			5320	3520	8599
0m					11170*	8100	8650	5500	6300	4130			5450	3580	8395
- 1.5m					9370*	8150	7650*	5460	5770*	4120			5100*	3890	7901
- 3m					6770*	6770*	5600*	5590					4060*	4060*	7066















- Notes:**
1. For lifting capacity including bucket, subtract total weight of bucket or bucket and quickhitch from above values.
  2. Lifting capacities are based on ISO 10567, that is: 75% of minimum tipping load or 87% of hydraulic lift capacity, whichever is the less. Lifting capacities marked\* are based on hydraulic capacity.
  3. Lift capacities assume that the machine is on firm, level ground.
  4. Lift capacities may be limited by local regulations. Please refer to your dealer.















**LIFT CAPACITIES – Dipper length: 3.09m, 6.24m T.A.Boom, Trackshoes: 600mm, No bucket. JS240/JS260 SC T.A.B.**

Reach	Reach from Swing Centre														
	1.5m		3m		4.5m		6m		7.5m		9m		Max. Reach		
															
Load Point Ht.	kg	kg	kg	kg	kg	kg	kg	kg	kg	kg	kg	kg	kg	kg	mm
7.5m							7170*	7170*					4870*	4870*	7292
6m					7400*	7400*	7750*	7130	6760*	4910			4610*	4110	8250
4.5m			15500*	15500*	10530*	10480	8260*	6740	6920*	4750			4550*	3560	8851
3m					11880*	9370	8830*	6250	6760	4510	5080	3380	4630*	3270	9167
1.5m					12460*	8500	8990	5810	6500	4270	4980	3280	4790	3160	9227
0m					11880*	8110	8670	5520	6310	4100	4910	3210	4880	3200	9038
- 1.5m			8300*	8300*	10430*	8040	8170*	5400	6240	4040			4860*	3420	8581
- 3m					8180*	8170	6570*	5450	4700*	4110			4130*	3930	7810

**LIFT CAPACITIES – Dipper length: 3.52m, 6.24m T.A.Boom, Trackshoes: 600mm, No bucket. JS240/JS260 SC T.A.B.**

Reach	Reach from Swing Centre														
	1.5m		3m		4.5m		6m		7.5m		9m		Max. Reach		
															
Load Point Ht.	kg	kg	kg	kg	kg	kg	kg	kg	kg	kg	kg	kg	kg	kg	mm
9m							5770*	5770*					4710*	4710*	6453
7.5m							6280*	6280*	5210*	5000			4220*	4220*	7819
6m							6590*	6590*	6360*	4980			4010*	3740	8718
4.5m			8940*	8940*	8380*	83870*	7920*	6850	6690*	4790	5190*	3490	3960*	3280	9288
3m					11420*	9600	8550*	6330	6780	4530	5090	3380	4030*	3020	9589
1.5m					12290*	8610	9000*	5830	6500	4270	4950	3250	4220*	2910	9647
0m			4250*	4250*	12070*	8080	8650	5490	6280	4060	4850	3150	4520	2940	9466
- 1.5m			8000*	8000*	10910*	7920	8370*	5320	6160	3960	4700*	3130	4650*	3120	9032
- 3m			10620*	10620*	8910*	7990	7030*	5320	5260*	3980			4060*	3540	8304
- 4.5m							4620*	4620*					4230*	4230*	6351

**LIFT CAPACITIES – Dipper length: 2.01m, 6.24m T.A.Boom, Trackshoes: 600mm, No bucket. JS240/JS260 LC T.A.B.**



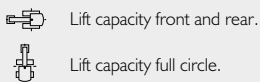











Reach	Reach from Swing Centre														
	1.5m		3m		4.5m		6m		7.5m		9m		Max. Reach		
															
Load Point Ht.	kg	kg	kg	kg	kg	kg	kg	kg	kg	kg	kg	kg	kg	kg	mm
7.5m					10040*	10040*							8680*	7980	5865
6m			14720*	14720*	10550*	10550*	8540*	7620					7710*	5870	7024
4.5m					11680*	11050*	8900*	7260	7360*	5170			7180*	4920	7723
3m							9250*	6810	7390*	4990			6810*	4460	8084
1.5m							9230*	6450	7240*	4810			6460*	4310	8152
0m							8600*	6280	6660*	4720			6030*	4410	7937
- 1.5m					8530*	8530*	7250*	6290					5340*	4840	7411
- 3m							4810*	4810*					4650*	4650*	6130

















- Notes:**
1. For lifting capacity including bucket, subtract total weight of bucket or bucket and quickhitch from above values.
  2. Lifting capacities are based on ISO 10567, that is: 75% of minimum tipping load or 87% of hydraulic lift capacity, whichever is the less. Lifting capacities marked\* are based on hydraulic capacity.
  3. Lift capacities assume that the machine is on firm, level ground.
  4. Lift capacities may be limited by local regulations. Please refer to your dealer.

















**LIFT CAPACITIES – Dipper length: 2.43m, 6.24m T.A.Boom, Trackshoes: 600mm, No bucket. JS240/JS260 LC T.A.B.**

Reach	Reach from Swing Centre														
	1.5m		3m		4.5m		6m		7.5m		9m		Max. Reach		
															
Load Point Ht.	kg	kg	kg	kg	kg	kg	kg	kg	kg	kg	kg	kg	kg	kg	mm
9m					9950*	9950*							9250*	9250*	4724
7.5m					8530*	9530*	8150*	7850					7890*	6840	6475
6m					10080*	10080*	8230*	7730	7150*	5310			7130*	5260	7540
4.5m					11240*	11240*	8660*	7340	7190*	5210			6680*	4490	8194
3m					12360*	10180	9100*	6870	7300*	5000			6360*	4110	8534
1.5m							9220*	6480	7250*	4800			6050*	3970	8599
0m					11170*	9290	8780*	6260	6840*	4670			5680*	4050	8395
- 1.5m					9370*	9340	7650*	6220	5770*	4670			5100*	4400	7901
- 3m					6770*	6770*	5600*	5600*					4060*	4060*	7055

**LIFT CAPACITIES – Dipper length: 3.09m, 6.24m T.A.Boom, Trackshoes: 600mm, No bucket. JS240/JS260 LC T.A.B.**

Reach	Reach from Swing Centre																
	1.5m		3m		4.5m		6m		7.5m		9m		Max. Reach				
																	
Load Point Ht.	kg	kg	kg	kg	kg	kg	kg	kg	kg	kg	kg	kg	kg	kg	mm		
7.5m							7170*	7170*					4870*	4870*	7292		
6m					7400*	7400*	7750*	7750*	6760*	5470			4610*	4590	8250		
4.5m					15500*	15500*	10530*	10530*	8260*	7520	6920*	5310			4550*	4000	8851
3m							11880*	10600	8830*	7020	7140*	5060	5780*	3810	4630*	3690	9167
1.5m							12460*	9700	9160*	6570	7230*	4830	5810*	3710	4880*	3570	9227
0m							11880*	9300	8980*	6270	7020*	4650	5340*	3640	5290*	3620	9038
- 1.5m					8300*	8300*	10430*	9230	8170*	6150	6310*	4580			4860*	3880	8581
- 3m							8180*	8180*	6570*	6210	4700*	4660			4130*	4130*	7810

**LIFT CAPACITIES – Dipper length: 3.52m, 6.24m T.A.Boom, Trackshoes: 600mm, No bucket. JS240/JS260 LC T.A.B.**

Reach	Reach from Swing Centre																				
	1.5m		3m		4.5m		6m		7.5m		9m		Max. Reach								
																					
Load Point Ht.	kg	kg	kg	kg	kg	kg	kg	kg	kg	kg	kg	kg	kg	kg	mm						
9m							5770*	5770*					4710*	4710*	6453						
7.5m							6280*	6280*	5210*	5210*			4220*	4220*	7819						
6m							6590*	6590*	6360*	5540			4010*	4010*	8718						
4.5m							8940*	8940*	8380*	8380*	7920*	7630	6690*	5350	5190*	3920	3960*	3690	9288		
3m									11420*	10850	8550*	7100	6950*	5090	5860*	3810	4030*	3420	9589		
1.5m									12290*	9820	9000*	6600	7120*	4820	5820*	3680	4220*	3300	9647		
0m									4250*	4250*	12070*	9270	8980*	6240	7020*	4610	5530*	3580	4560*	3340	9466
- 1.5m									8000*	8000*	10910*	9110	8370*	6070	6490*	4500	4700*	3560	4650*	3550	9032
- 3m									10620*	10620*	8910*	8910*	7030*	6080	5260*	4530			4060*	4010	8304
- 4.5m													4620*	4620*					4230*	4230*	6351

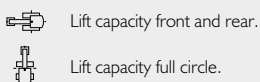

- Notes:**
1. For lifting capacity including bucket, subtract total weight of bucket or bucket and quickhitch from above values.
  2. Lifting capacities are based on ISO 10567, that is: 75% of minimum tipping load or 87% of hydraulic lift capacity, whichever is the less. Lifting capacities marked\* are based on hydraulic capacity.
  3. Lift capacities assume that the machine is on firm, level ground.
  4. Lift capacities may be limited by local regulations. Please refer to your dealer.











**ONE COMPANY, OVER 300 MACHINES.**

Your nearest JCB dealer

**Hydraulic Excavator JS240/260 LC/SC/NLC**

Engine power: 140kW (188hp) Bucket capacity: 0.65 – 1.65m<sup>3</sup>

Operating weight: 26504 – 28500 kg

JCB Sales Limited, Rokester, Staffordshire, United Kingdom ST14 5JP.

Tel: +44 (0)1889 590312 Email: salesinfo@jcb.com

Download the very latest information on this product range at: [www.jcb.com](http://www.jcb.com)

©2009 JCB Sales. All rights reserved. No part of this publication may be reproduced, stored in a retrieval system, or transmitted in any form or by any other means, electronic, mechanical, photocopying or otherwise, without prior permission from JCB Sales. All references in this publication to operating weights, sizes, capacities and other performance measurements are provided for guidance only and may vary dependant upon the exact specification of machine. They should not therefore be relied upon in relation to suitability for a particular application. Guidance and advice should always be sought from your JCB Dealer. JCB reserves the right to change specifications without notice. Illustrations and specifications shown may include optional equipment and accessories. All images are correct at time of print. The JCB logo is a registered trademark of J C Bamford Excavators Ltd.



9999/5863 en-GB 09/14 Issue 1 (T4)

